



# Essence™ Series

Wood Windows & Doors







Casements with fixed casements above.  
Pine interior and brushed chrome hardware.

re-imagined

## Essence™ Series. Wood windows. Re-imagined.



Natural wood interiors make rooms feel warm, inviting and comfortable.



## Dependability. Re-defined.

For almost 50 years, Milgard has been known for dependability. In fact, we were one of the first manufacturers to extrude our own vinyl and pultrude our own fiberglass structural components. By creating our own materials, we can monitor quality more closely.

Today, we continue our tradition of excellence by introducing a new wood window that lives up to the Milgard name. New Essence™ Series windows and doors embody beauty and strength. Style and innovation. Comfort and creativity. Design and durability.

Inside, Essence windows are natural, solid wood. Outside, they have a strong fiberglass exterior that won't rot or warp like ordinary wood-only windows. This exceptional durability is why Milgard can offer something you simply won't find with other wood windows: a Full Lifetime Warranty with Glass Breakage Coverage.

Our creativity and innovative spirit pushed us to re-imagine window design and energy efficiency. We have patents pending for innovations such as a new tilt latch, sash binder, DuraBlock™ mull system and our HydroGard™ water management system. Essence delivers it all and in substantially shorter times than other wood windows — even for custom sizes.

# Imagined



Gliders with picture windows above.  
Painted white interior and oil rubbed bronze hardware.

*Blur the line between indoors and out by installing a series of windows or French doors on a wall in your home. In addition to making the space feel bigger, they allow plenty of natural light into your room.*

*— Lori Dennis, ASID, LEED AP*

# re-definin

Milgard® Essence™ windows and doors do so much for your home. They frame great views, brighten rooms, let in fresh air and provide stunning architectural focal points. Essence windows also improve your home's curb appeal and value, making them a smart investment. In fact, if you compare replacing windows with other home improvements you'll discover window replacements give you a higher return on your investment (ROI). According to Remodeling magazine's 2008-2009 "Cost vs. Value" report, window replacement delivers a 78% ROI, which is better than both a master bedroom renovation (64%) and a kitchen renovation (73%).

In the following pages, we'll show you how you can express your personal sense of style with Essence Series through color, wood species, window shapes, hardware, configurations and more. Look for tips from interior designer Lori Dennis for even more great ideas.



*It's important to consider the interior and exterior style of your home's architecture and design when selecting a window style, color and hardware. For example, in a contemporary home I love the look of a white window frame paired with brushed chrome hardware. This combination is fresh, stylish and works great with any wall or floor material.*

*- Lori Dennis, ASID, LEED AP*



80



*Incorporating plenty of windows into a room provides a homeowner with two huge bonuses. First, seeing the interior and exterior spaces as a whole makes a room virtually double in size. This effect is called the visual square footage gain. Second, during the daylight hours, windows flood your room with natural light. It's the most pleasant source of illumination and saves you money by reducing your energy use.*



*My designs are all about the power of color. One of my best interior tricks is to order primed Essence windows and paint them in custom colors. It makes the windows pop and adds a unique signature style to my rooms.*



*Details like door and window hardware are the keys to defining your design style.*



*Lori Dennis, one of the nation's top interior designers.*

Q:

*Why is the Milgard family of windows and doors your choice for the homes you design?*

A:

*My clients deserve the best: classic, beautiful things that last for lifetimes. It just doesn't matter how good something looks if it doesn't have the power to stand up to the test of time. I choose Milgard because I don't have to sacrifice style, functionality and great looks if I want a product that delivers superior performance.*

# The anatomy of a better wood window.

When Milgard set out to create a wood window, good wasn't good enough. We started from scratch and re-thought just about everything.

Essence™ Series window interiors have many innovative new features, such as our new tilt latch, with recessed release on our double hung and glider windows. This new feature gives the window a sleek, clean look and makes the window easy to tilt open for convenient cleaning. Other latches can be hard to operate because they require you to simultaneously compress together both levers while the sash engages and disengages. Milgard tilt latches, on the other hand, are as easy to use as pushing a button; once the buttons are pressed they stay compressed.

Unlike traditional wood windows and even aluminum clad wood windows, our fiberglass exterior is resistant to water, cold, heat, insects, salt air and ultraviolet rays, which make our windows last longer and require very little maintenance. Plus, unlike wood, fiberglass won't crack, peel, bend, warp or stick due to expansion and contraction.

# anatomy of

## Advanced water management system.

In the rare event that water enters the sash system, the new water management system keeps it away from the beautiful wood interior.

Water drains through a specially designed water channel and drainage holes.

Water exits the sash behind the bottom rail seal, designed to minimize the water coming in contact with the wood interior. All of this allows the window to perform at a higher design pressure than most other wood windows, making Essence windows ideal for all conditions.

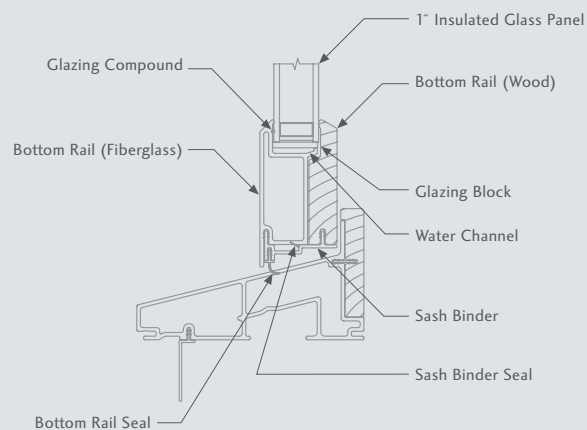

### Fiberglass Exterior

Choose from 15 colors for your window exterior. Double-walled, pultruded fiberglass gives the window exceptional strength and resistance to thermal conductivity.

### Energy Efficiency

All Essence™ Series windows meet ENERGY STAR® requirements. Choose optional energy packages that boost efficiency by up to 30% as compared to our standard offering.

### Hardware

Only Milgard brings you the easy-to-use SmartTouch® lock, and sleek, low profile tilt latches. Other hardware options include spoon lock and folding nesting operating handles for casements and awnings.

### Mulling

Milgard® Essence Series windows use a newly engineered mulling system, DuraBlock™, that more securely connects multiple units, creating a tight seal that protects against air and water infiltration.

### Performance Grade Rating

The performance grade rating is a measure of the amount of pressure a window or door is designed to withstand when closed and locked. Better performance is indicated by a higher PG number.

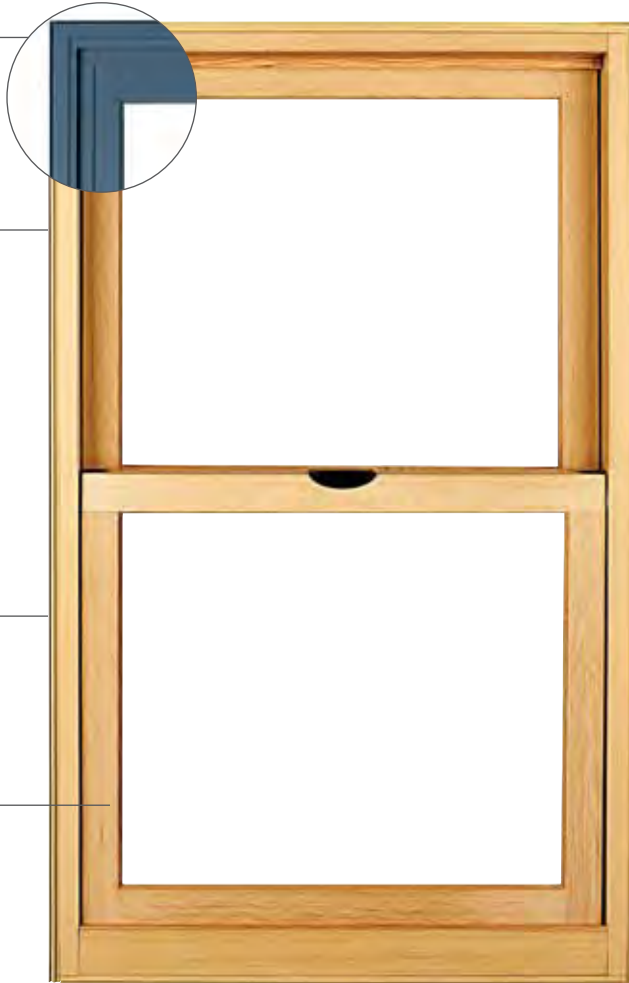

# a window



### Proprietary sash binder.

Milgard engineers created a new sash binder that securely combines the wood interior with the fiberglass exterior.



### Solid wood interior

Choose from Pine, Primed Wood or Clear Vertical Grain Douglas Fir.

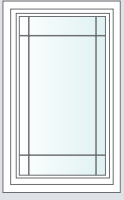

### Casement

A casement window is hinged on one side and opens outward, providing excellent ventilation. It also offers unobstructed views because unlike double hung or gliding windows, it has no center rail.

---

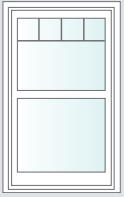

### Double Hung

On double hung windows, both the top and bottom sashes open for ventilation. The sashes also tilt inward to make it easy for you to clean the exterior of the window safely.

---

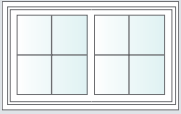

### Glider

The horizontal sliding operation makes it easy to open windows over kitchen counters and sinks.

---

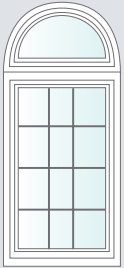

### Radius

Used by themselves or in combination with other windows, radius windows are a fantastic way to create a stunning focal point. Or use an arch window as a unique door transom.

---

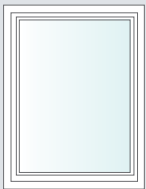

### Picture Window

Nothing gets in the way of a great view. Ideal for both modern and traditional homes.

---

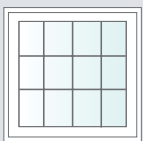

### Awning

Hinged at the top, an awning window opens outward. The glass protects the opening, so you can enjoy ventilation even when it rains. Think about using awning windows in conjunction with picture windows.





# windlow

Casement with painted white interior. 2 1/4" horizontal vintage grid combined with 3/4" vintage grids.



Awnings with Douglas Fir interior and oil rubbed bronze hardware.





Feeling like your home's exterior could use a makeover? Add a touch of drama by pairing a neutral background with a bold accent color, like Evening Sky. The combination will brighten your façade and your day.  
- Lori Dennis, ASID, LEED AP

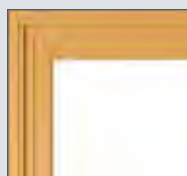

Casements and picture windows with Evening Sky exterior.

## Color that stays beautiful year after year.

Milgard applies paint using the latest advances in powder coat finishing technology — the same technology that's used in aerospace and automotive applications. This makes our powder coat much harder than conventional finishes, providing increased protection against fading, chipping and scrapes. In fact, we expect our windows will meet the requirements of the American Architectural Manufacturers Association (AAMA) 624 certification which no other fiberglass window manufacturer currently has. Milgard is also a member of the Powder Coating Institute, which is committed to developing high-quality non-polluting finish technologies.



## Operating styles for every type of home.

Milgard® Essence™ Series windows are available in several operating styles, which makes them the ideal complement to many styles of homes throughout the country.

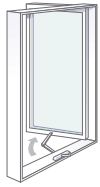

Casement

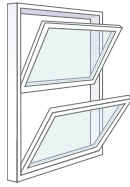

Double Hung

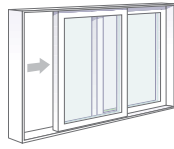

Glider

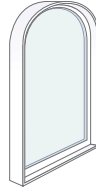

Radius

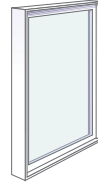

Picture Window

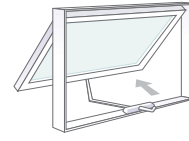

Awning



## Even sight lines.

The profiles on Milgard Essence Series are consistent among all operating styles. So, for example, if you place a casement window next to a picture window, the matching heights and widths of the frame profiles create clean, consistent sight lines. Plus, all windows are proportioned for an architecturally-accurate wood window look.



Casement window

Casement picture window

## Grids. Re-think what's possible.

Your choices expand almost exponentially with grids.

Between the glass options:



Flat grid



Sculptured grid

Simulated Divided Lite Grid Options:

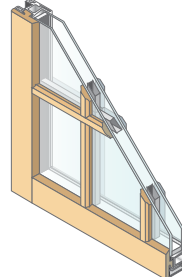

3/4" Vintage SDL



1-1/8" Vintage SDL



2-1/4" Vintage SDL



*Many people don't know this, but originally window grids were not used for decoration, they were purely functional. This is because sheets of glass were only able to be manufactured in small six inch pieces. The purpose of grids was to unite many small pieces of glass to form large windows which would allow more natural daylight in dark rooms. Window makers elevated the grid formations to an artisan product by creating elaborate shapes and patterns out of the grids. Using grids in modern windows is mostly for decoration, representing character, authenticity and a sense of tradition.*

*- Lori Dennis, ASID, LEED AP*

## Glass options.

For rooms, such as the bathroom, where you want a little more privacy, we offer obscure glass options.

**Obscure:** use for privacy or decorative flair.



P516

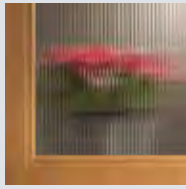

Narrow Reed

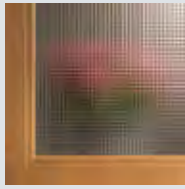

Cross Reed



Aquatex

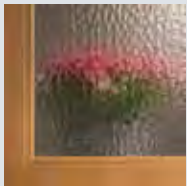

#42 Clear



Glue Chip



Rain

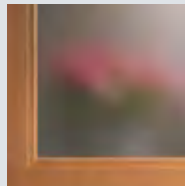

Matelux

### Tempered:

For applications where safety glass is required, such as bathrooms and patio doors, Tempered glass is ideal for reducing the likelihood of injury in the event of glass breakage.

### Laminated:

Laminated glass is very effective in reducing exterior noise transmission.

**Tinted:** use for additional shading from direct sunlight.

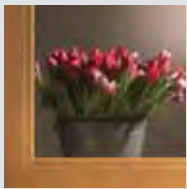

Bronze

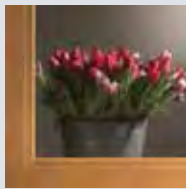

Gray

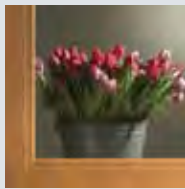

Evergreen

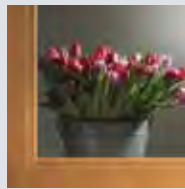

Azurlite



## Complete the look with hardware.

For our double hung and glider windows, choose between the sleek and innovative Milgard® SmartTouch® lock or the historically accurate look of a spoon lock. Folding nesting operating handles are standard on casements and awnings.

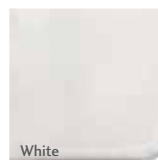

White

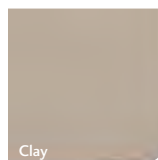

Clay

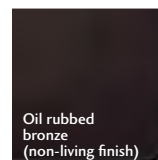

Oil rubbed bronze  
(non-living finish)



Brushed chrome

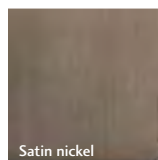

Satin nickel

With each hardware option available in one of five finishes, Milgard makes it easy to match almost any design aesthetic.



A photograph of a dining area. In the foreground, a wooden dining table is partially visible with a white lace runner. Three light-colored chairs are tucked under the table. On the table, three clear glass vases of varying heights hold a bouquet of white lilies with green leaves. Behind the table is a large, multi-paned window with a thick wooden frame. The window is divided into four main sections, each further subdivided into smaller panes. Through the window, a city skyline with several tall buildings is visible under a clear blue sky. The word "homes" is overlaid in a large, light-colored, serif font across the middle of the image, partially obscuring the window and the flowers.

homes

# Casement





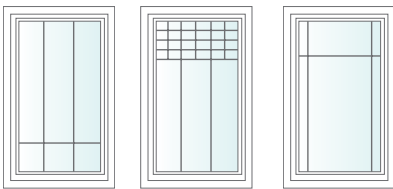

**Milgard® Essence™ Series casement windows** combine unobstructed views with great function. The fold down operator and slim line locking mechanism give the window's interior a clean, elegant look. Weather stripping and sealing around the windows achieves a performance grade rating of PG 60,\* which makes the Essence casement window one of the highest rated wood windows in the industry.

Casements are available in larger sizes (up to 3-0 x 7-0), among the largest available in the industry.

Also available: optional extruded color-matched screen frame with internal corner keys and PureView® fiberglass mesh window screen. Its smaller yarns and finer weave provide 15% more openness than our standard screen for clear, cleaner views of the outside from inside your home.



\*Performance grade is a target value and is subject to change. 3050 casement test size.



# Double Hung



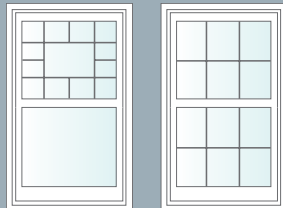

*Nothing says Americana like a double hung window. Whether a Shingle Style, Craftsman, Cape Cod or California Bungalow, when I want a window that represents a pure American style, there's only one I choose and that's a double hung.*

*- Lori Dennis, ASID, LEED AP*

**Milgard® Essence™ Series double hung windows** have architecturally accurate details such as a 3<sup>1</sup>/<sub>4</sub>" tall exterior bottom rail on the sash and 14° exterior sloped sills. The new tilt latch with recessed release and the SmartTouch® lock make the window very easy to open and create a streamlined, clean look. You can also choose a spoon lock for a more historically authentic look or to more closely complement existing wood windows in your home. Weather stripping and sealing around the windows achieves a performance grade rating of PG 45\* and a very low air filtration, both indications of a well designed window.

Also available: optional extruded color-matched screen frame with internal corner keys and PureView® fiberglass mesh window screen. Its smaller yarns and finer weave provide 15% more openness than our standard screen for clear, clean views from inside your home.



\*Performance grade is a target value and is subject to change. 3056 double hung test size.

# Awning







Modern styling combined with the beauty of wood make **Milgard® Essence™ Series awning windows** a popular choice for contemporary or Craftsman homes. Awnings are hinged on the top to tilt outward, which allows for ventilation even in bad weather. Consider using awning windows as an accent above or below picture windows. Awnings are also available in fixed models giving you the option to use them as a singular picture window or in a grouping. If you choose to pair awnings with other operable styles, you can choose an optional taller bottom rail on the sash that matches traditional proportions and sight lines of the bottom sash of the double hung windows.

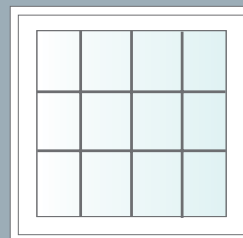
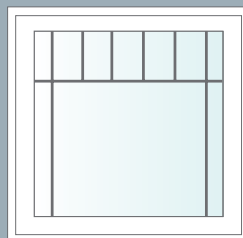
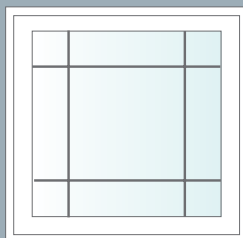

# Picture Window



**Milgard® Essence™ picture windows** are available in casement, double hung, or standard picture window styles. With no obstructing rails, picture windows help you make the most of a great view. They are also ideal for window groupings. When mulling a picture window next to a window that is operable, meaning it opens and closes, you want to use a fixed casement or double hung picture window.

Standard picture windows, most commonly used as transom windows, have equal sight lines when used above or below operable windows, as seen in the image above. These windows are constructed without a fixed sash and should not be used next to operable windows. When combining window units, Milgard uses secure DuraBlock™ mulling technology.





Double hung picture window



Standard picture window

Milgard® Essence™ Series picture windows are available in custom sizes ranging from a minimum width and height of 17<sup>1</sup>/<sub>2</sub>" to a maximum width of 143<sup>1</sup>/<sub>2</sub>" and a maximum height of 95<sup>1</sup>/<sub>2</sub>". Weather stripping and sealing around the window achieves a performance grade rating of PG 60\*.

All picture window styles come with a wide selection of interior wood species options and durable exterior finishes.

\*Maximum of 48 sq. ft.

\*\*Performance grade is a target value and is subject to change. 6060 picture window test size.

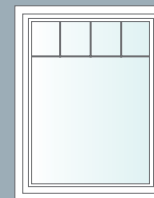
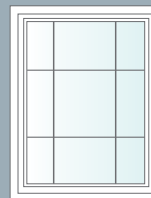

*Create your own signature design by adding unique grid formations to large scale picture windows.*

*- Lori Dennis, ASID, LEED AP*



# Glider



**Milgard® Essence™ Series glider windows** open almost effortlessly. Clean lines complement homes in a wide range of styles. As with our double hung windows, gliders feature the tilt latch for removal of vents and the SmartTouch® lock, both of which make the window very easy to open and create a streamlined, clean look. You can also choose a spoon lock for a more traditional look. Weather stripping and sealing around the window achieves a performance grade rating of PG 40,\* among the strongest in the industry for a glider window.

Also available: optional extruded color-matched screen frame with internal corner keys and PureView® fiberglass mesh window screen. Its smaller yarns and finer weave provide 15% more openness than our standard screen for clear, clean views and greater curb appeal.

\*Performance grade is a target value and is subject to change. 6050 glider test size.

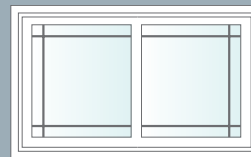
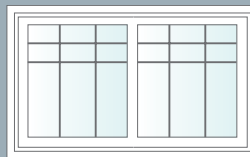
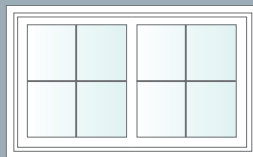



With so many shapes, **Milgard® Essence™ Series specialty windows** let you get creative with stunning combinations. Essence windows use DuraBlock™ technology that securely connects multiple units, creating a tight seal that protects against air and water infiltration. Consider combining your specialty windows with another operable style for ventilation. Specialty windows are available in shapes such as:

- True half round
- Eyebrow
- Spring line radius
- Gable (shown above)
- Radius picture window

*I love the flexibility that grids add to my design arsenal. Depending on the look that I'm going for, from traditional to modern, incorporating grids helps me define the exact style and look of window needed to complete a successful design.*

*— Lori Dennis, ASID, LEED AP*



# Patio Doors





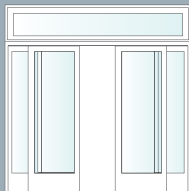

## Patio Doors. Refined.

**Milgard® Essence™ Series patio doors** are the perfect companion to Milgard Essence Series windows. Essence doors combine the durability of a fiberglass exterior and the beauty of a wood interior in Pine or Clear Vertical Grain Douglas Fir.

Available in French swinging, with or without operable sidelites, and French-style sliding door models. Choose any of our factory-painted exterior colors.

Milgard Essence In-Swing and Out-Swing patio doors feature designer hardware, a multi-point locking system and operable sidelites. The hardware is available in the same finishes as the windows so you can give your home a unified, consistent look; many popular off-the-shelf hardware brands are compatible with the Milgard door hardware configurations.

All Milgard patio doors are custom made-to-order. Make your patio door your own with several options to choose from.

## Glass options for patio doors.

Patio door glass options allow you to maintain privacy throughout your home.

### Obscure: use for privacy or decorative flair.

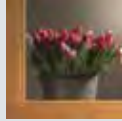

P516

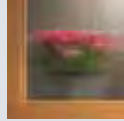

Narrow Reed

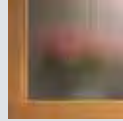

Cross Reed

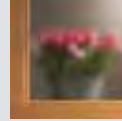

Aquatex

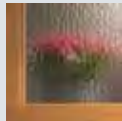

#42 Clear

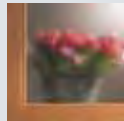

Glue Chip

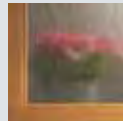

Rain

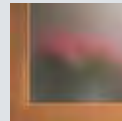

Matelux

### Tinted: use for additional shading from direct sunlight.

Available in a variety of thicknesses and tones such as:

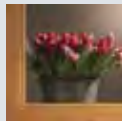

Bronze

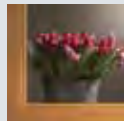

Gray

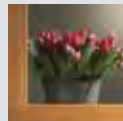

Evergreen

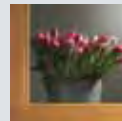

Azurlite

### Tempered:

For applications where safety glass is required, such as bathrooms and patio doors, Tempered glass is ideal for reducing the likelihood of injury in the event of glass breakage.

### Laminated:

Laminated glass is very effective in reducing exterior noise transmission.

Looking for some privacy without losing the effect of natural light? Essence™ Series glass options give you many choices for creating a design statement that also makes you feel like your home is a retreat from the rest of the world.

### Hardware finishes.

Coordination and consistency are important to a well designed home. That's why we are offering our patio door hardware in the same finishes available for Milgard® Essence Series windows.

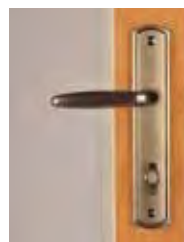
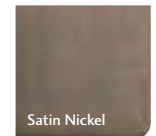
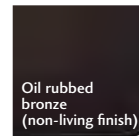
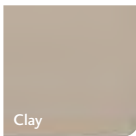

Mastri™ hardware



Madrona™ hardware

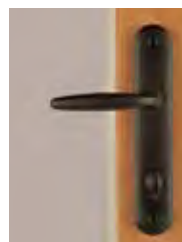

Meridian™ hardware

Today residential design is all about indoor/outdoor living and we see a lot of French doors connecting our living spaces to the exterior landscape. A design problem in the past has been that sidelites were not operable and if you wanted fresh air, you had one choice: open the doors. For parents of small children or pet owners, leaving the doors open wasn't a good option, forcing you to compromise your comfort. Now with operable sidelites your indoor/outdoor relationship is in great harmony, no compromise necessary.

- Lori Dennis, ASID, LEED AP



Choose from 15 exterior colors.

Milgard® Essence™ Series patio doors are available in the same exterior colors as Essence windows, giving your home a consistent look. Solid wood interior options include Pine, Primed Wood, and Clear Vertical Grain Douglas Fir.



\*Frost, Harmony, Fog and Bark are available within standard lead times. Other colors will have slightly longer lead times. Colors shown are approximate due to printing limitations.







## Window Hardware

Only Milgard brings you the easy-to-use SmartTouch® lock and new tilt latches with sleek, low profiles. Other hardware options include spoon lock and folding nesting operating handles.



Folding handle

Spoon lock

SmartTouch lock

Tilt latch

Milgard® Essence™ Series casements have innovative hinges that allow for larger window sizes that open 90°.

# a better wood

When you compare Milgard Essence Series wood windows to other wood windows, it's clear why Milgard is the smart choice.

### Essence Series Wood Window vs. Traditional Wood Window

	Essence Series Wood Windows	Traditional Wood Window with wood exterior
Mortis & Tenon style sash construction	YES	YES
Full Lifetime Warranty with Glass Breakage Coverage	YES	NO
Simple one-touch operation to open and close	YES	NO
Easy to use push button tilt latches	YES	NO
Durable powder coated fiberglass exterior	YES	NO
15 factory applied exterior color options	YES	NO
Contemporary and vintage grid options	YES	YES
High performance glass options	YES	YES
Available in short lead times even for custom sizes	YES	NO
Unique water barrier to prevent water infiltration	YES	NO
Equal sight lines on all operating styles	YES	YES
Requires routine maintenance and care	NO	YES
May rot and warp over time	NO	YES



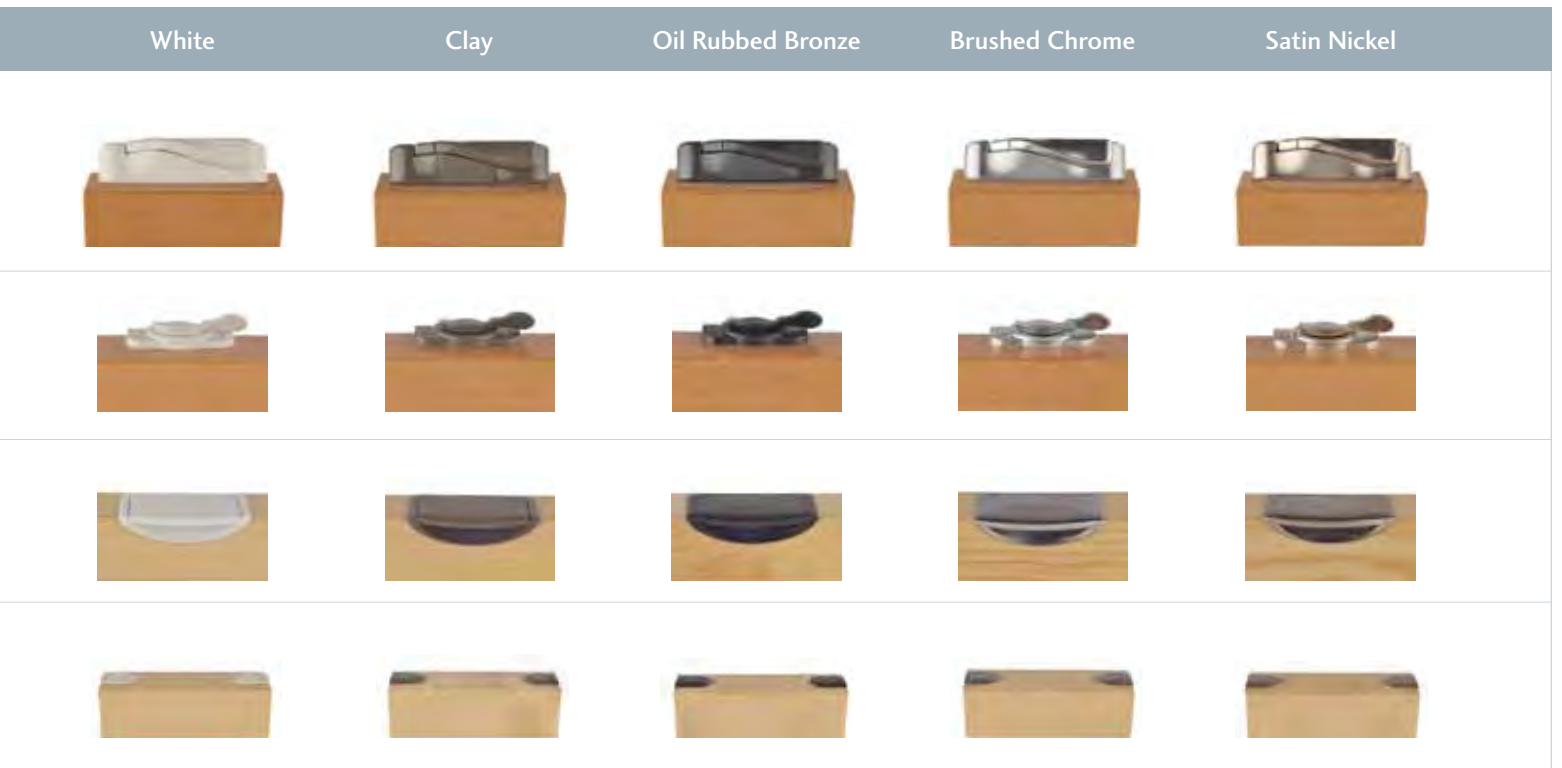

# window.

Milgard windows are built to outperform the competition	Milgard® Essence™ Series Wood-fiberglass	Aluminum or Vinyl Clad Wood Competitor	Composite Competitor
Available in 15+ factory-finish colors	Yes	Yes	No
Paintable	Yes	No	Yes
AAMA-rated paint finish (durability, weatherability)	Yes	Yes	No
Dent resistant	Yes	No	Yes
Strong—provides watertight structure of window	Yes (PG 60 rating)*	Wood is structural (DP 40-DP 60)	Yes (DP 50)
Looks like “real” wood window	Yes	Yes	No
Energy-efficient	Yes (0.30 U-factor)*	(0.30-0.31 U-factor)*	(0.30 U-factor)*
Full Lifetime Warranty, including parts and labor	Yes	No	No

\* Based on preliminary test simulations  
 \*\*Warranty information as of 9/23/2011

ARIZONA  
Phoenix

CALIFORNIA  
Hollister  
Sacramento  
Simi Valley  
Temecula

COLORADO  
Denver

ILLINOIS  
Chicago

NEVADA  
Las Vegas

OREGON  
Portland

TEXAS  
Dallas/Fort Worth

UTAH  
Salt Lake City

VIRGINIA  
Fredericksburg

WASHINGTON  
Tacoma

CANADA  
British Columbia

DuraBlock™, Essence™, HydroGard™, Madrona™, Mastri™, Meridian™, PureView®, and SmartTouch® are all trademarks of Milgard Manufacturing, Inc.

ENERGY STAR® is a registered trademark of the U.S. Department of Energy. Milgard Windows & Doors is proud to be an ENERGY STAR® partner, with all Essence Series products ENERGY STAR® qualified for all U.S. zones.

Milgard Essence wood windows meet criteria for structural integrity and reliable performance established by the American Architectural Manufacturers Association (AAMA). Consult your Milgard representative for specific test information.



*Clearly the best.™*

1.800.MILGARD • milgard.com